



IMPORTANT

OPERATING INSTRUCTIONS MANUAL

HELPFUL HINTS & TIPS

“NSF CERTIFIED TO THE ASTM SAFETY SPECIFICATION F 2208”



MODEL PGRM - 2

85dB Horn at 10 Feet

This product has been designed to aid in the detection of unwanted intrusions into unsupervised pools. POOLGUARD IS A SAFETY ALARM SYSTEM AND NOT A LIFE SAVING DEVICE. “This device is not intended to replace any other safety consideration - i.e., adult supervision, lifeguards, fences, gates, pool covers, locks, etc., and some devices may not detect gradual entry.”

CERTIFICATION

NSF International Certifies that the POOLGUARD Pool Alarm Model PGRM-2 conforms to the requirements of ASTM F2208 - Standard Safety Specification for Residential Pool alarms.

1. Certified to ASTM F2208 for performance.
 2. Certified to NSF/ANSI Standard 50 for material safety. Certified pool and spa end use temperatures.
-

POOLGUARD Pool Alarm Model PGRM-2 will meet or exceed all parts of the Tennessee Pool Alarm requirements of the Katie Beth Law.

INSPECTION

POOLGUARD is packaged in a shipping carton that minimizes the chance of damage due to handling. Check for damage and confirm that the contents of the carton include the following items:

- POOLGUARD Unit
- Handle
- Red Reset/Sleep Key
- Remote Receiver and Power Supply
- Operating Instructions Manual

If an item is missing, contact either the place of purchase or PBM Industries, Inc. for replacement.

CARE AND HANDLING

POOLGUARD is constructed from sturdy plastic to withstand the adverse moisture environment of a swimming pool. Care needs to be taken when handling to ensure against being dropped, kicked, etc. **ALWAYS REMOVE THE POOL UNIT FROM THE POOL WHEN THE POOL IS BEING USED. STORE THE ALARM IN THE UPRIGHT POSITION (See Figure 1) AWAY FROM POOL ACTIVITY.** If the pool unit accidentally falls into your pool, remove it immediately and drain the water from it. Take the pool unit apart as indicated in the Battery Installation/Replacement section and remove the battery. Remove all the water from the inside of the unit, the battery and the circuit board area with a paper towel or cloth. Completely test the alarm before each use as described in the manual to ensure proper operation.

CAUTION: KEEP THE RED RESET/SLEEP KEY OUT OF THE REACH OF CHILDREN. INTERNAL MAGNET MAY BE HARMFUL IF SWALLOWED!

ATTACHING HANDLE

The two handle screws are located in the top of the alarm, remove them and attach the handle, (See Figure 1).

OPERATING YOUR ALARM

RESET/SLEEP MODE (SEE FIGURE 1)

RESET: When the pool unit is installed in the pool and the horn is sounding; place the red reset/sleep key on the reset/sleep decal to reset and silence the alarm. The pool unit is now monitoring your pool for an intrusion.

SLEEP MODE: When the pool unit is removed from the pool and the horn is sounding; place the red reset/sleep key on the reset/sleep decal for 3 to 4 seconds to activate sleep mode and silence the alarm. To store the alarm, place the alarm in the upright position (See Figure 1). **The pool unit will automatically wake up when it is re-installed into your pool!**

SILENT INSTALLATION AND REMOVAL FEATURE

- The Poolguard system will sound an alarm (Horn will sound) when you install or remove the pool unit from your pool. If you would like the Poolguard system not to sound an alarm (Horn will not sound) when you install or remove the pool unit from your pool, follow the directions below.

1. SILENT INSTALLATION (HORN WILL NOT SOUND)

- Hold the red reset/sleep key on the reset/sleep decal for 1 second until you hear the pool units horn beep. Remove the red reset/sleep key, you now have 10 seconds to install the pool unit into your pool without the horn sounding. **AFTER 10 SECONDS, THE POOL UNITS HORN WILL BEEP INDICATING THAT POOL-GUARD IS NOW MONITORING YOUR POOL FOR AN INTRUSION. IF THE POOL UNIT WAS NOT INSTALLED INTO YOUR POOL, IT WILL GO TO SLEEP.**

2. SILENT REMOVAL (HORN WILL NOT SOUND)

- Before removing the pool unit from your pool. Place the red reset/sleep key on the reset/sleep decal for 1 second until you hear the pool units horn beep. Remove the red reset/sleep key, you now have 5 seconds to remove the pool unit from your pool without the horn sounding. **AFTER 5 SECONDS THE POOL UNITS HORN WILL BEEP. IMPORTANT: IF THE POOL UNIT WAS REMOVED FROM YOUR POOL, THE POOL UNIT WILL GO TO SLEEP. BE SURE TO STORE YOUR ALARM IN THE UPRIGHT POSITION (SEE FIGURE 1). IF THE POOL UNIT WAS NOT REMOVED FROM YOUR POOL, IT WILL CONTINUE TO MONITOR YOUR POOL FOR AN INTRUSION.**

(Cont. on next page)

SILENT INSTALLATION AND REMOVAL FEATURE (Cont.)

3. POOLGUARD has designed this feature for “ONLY” those who have the responsibility of removing the alarm from the pool!

BATTERY INSTALLATION / REPLACEMENT

(Battery not included)

POOLGUARD is powered by a standard 9 volt alkaline battery, **POOLGUARD recommends Energizer No. 522.** To install or replace the battery:

- Remove the screw from the bottom of the unit, **(See Figure 1).**
- Carefully slide out electronics assembly; do not pull or jerk on internal hook up cable. (If necessary, gently shake unit to remove assembly.)
- Remove old battery and check for leakage or corrosion. (Remove any leakage or corrosion if present before installing new battery.)

IMPORTANT: WHEN A 9 VOLT BATTERY IS FIRST INSTALLED IN THE POOL UNIT, THE HORN WILL SOUND. TO SILENCE THE ALARM HOLD THE RED RESET/SLEEP KEY ON THE RESET/SLEEP DECAL FOR 3 TO 4 SECONDS TO ACTIVATE SLEEP MODE AND SILENCE THE ALARM. THE POOL UNIT WILL AUTOMATICALLY WAKE UP WHEN IT IS INSTALLED INTO THE POOL.

- Install a new battery by attaching the battery snap **(BE SURE THE CONNECTION IS TIGHT)**. Slide battery into battery holder.
- Slide the electronic assembly into the pool unit; **DO NOT PUT IN UPSIDE DOWN OR PINCH THE INTERNAL HOOK UP CABLE.**
- Replace the screw, hand tighten until screw is all the way in and flush against the pool unit.

To prevent possible damage, battery should be removed whenever storing the alarm, for an extended period of time.

ON/OFF INDICATOR - GREEN LED

When POOLGUARD is installed and monitoring your pool for an intrusion, the green LED will flash once approximately every 10 seconds to indicate that the alarm is ON and OPERATING. When POOLGUARD is installed in your pool and the alarm is sounding, the green LED will flash approximately 2 times per second.

When POOLGUARD is removed from your pool the GREEN LED will not flash indicating that the alarm is OFF and NON-OPERATIONAL.

LOW BATTERY FUNCTION

The POOL UNIT AND THE REMOTE RECEIVER will beep once approximately every 10 seconds to alert you that the battery is low in the pool unit and needs to be replaced.

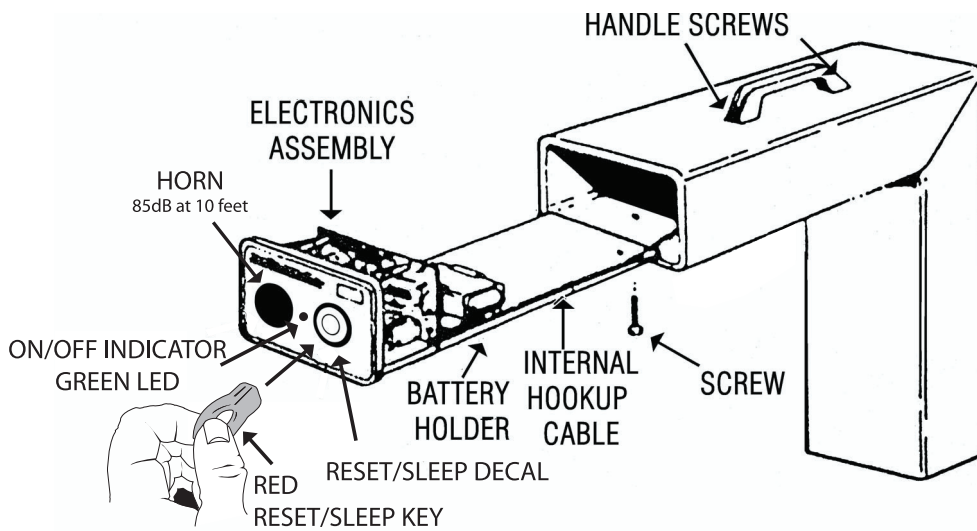

POOL UNIT **FIGURE 1**

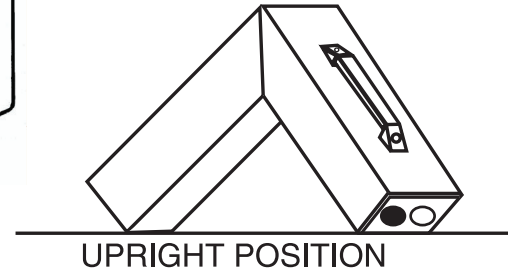

PLACEMENT IN YOUR POOL

Figure 2 illustrates locations best suited for detecting intrusions from any area of the pool. If your pool is larger than 800 square feet, if you have more than 2 return lines, any concerns about the size, or if you have an irregular shaped pool or water features such as waterfalls, please call customer service to clarify the recommended number of alarms and locations for alarms: 1-800-242-7163. Poolguard Pool Alarms have been tested and comply to the ASTM Standard Specifications for Residential Pool Alarms ASTM F 2208, in a 16' x 32' pool. POOLGUARD Model PGRM-2 can be used in pools up to 20' X 40' or 800 square feet.



FIGURE 2

Pools 800 Square Feet and Smaller.

(Cont. on next page)

PLACEMENT IN YOUR POOL (Continued)

POOLGUARD automatically compensates for variations in pool levels within the unit's operating range. The unit utilizes a sensing throat which projects into the water and is designed to operate in most pools with an in-wall skimmer. The sensing throat cannot be less than 2.5 inches, **(See Figure 3)**, and not more than 5.5 inches into the water, POOLGUARD recommends that the sensing throat be approximately 4 inches in the water. POOLGUARD Model PGRM-2 can be used with a SOLAR BLANKET on the pool. POOLGUARD can also be used in spas.

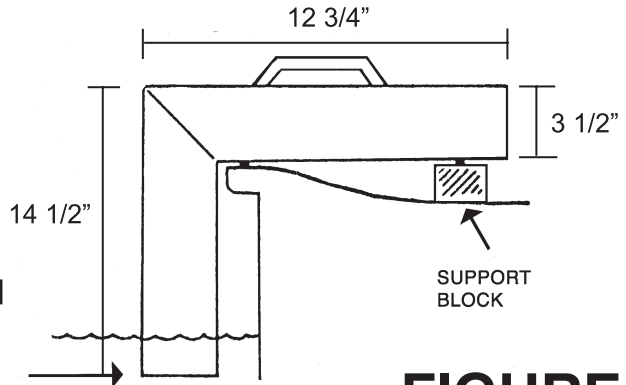

SENSING THROAT CANNOT BE LESS THAN 2.5" IN THE WATER, POOLGUARD RECOMMENDS THAT THE SENSING THROAT BE APPROXIMATELY 4" IN THE WATER

FIGURE 3

IMPORTANT

POOLGUARD may not function properly if your pool's water level is not maintained within the required levels of your alarm. Also, the unit may not operate effectively while certain types of automatic pool cleaners are in operation.

Some irregular shaped decks may not provide a level foundation for the unit by the pool's edge. This minor problem can be overcome by appropriately supporting the unit, **(See Figure 3)**.

REMEMBER THAT THE POOL UNIT MUST BE REMOVED FROM POOL BEFORE SWIMMING!

TEST BEFORE USING

To ensure effectiveness, test **POOLGUARD** every time you place it into the pool by performing the following procedure:

- **POOLGUARD DOES NOT HAVE AN ON/OFF SWITCH**

When the alarm is in the pool it is always in the **ON** position and cannot be turned off. When the alarm is out of the pool it is always in the **OFF** position.

- To test your alarm push an object of appropriate volume and weight off the deck edge at the farthest location from the alarm. (A four (4) gallon jug of water or 3-one (1) gallon jugs of water tied together are ideal for testing.) The alarm should sound when the water action caused by the intrusion reaches the unit. It may take a few seconds for the alarm to react to the water action.
- After resetting the alarm and allowing time for the water action to settle, repeat the procedure from another point in the pool until you are confident of detection performance.
- **POOLGUARD** includes a timer function which automatically resets the unit after the alarm has sounded for approximately 5 minutes.

ADJUSTING YOUR RETURN LINE FITTINGS

The POOLGUARD alarm should not be placed too close to a return line, also do not place POOLGUARD in a location in the pool where a return line is pointing in the alarms direction. Water turbulence may be too strong, falsely setting the alarm off or the water turbulence may interfere with the alarms ability to detect an intrusion. If you have more than 2 return lines please call customer service at 1-800-242-7163. It is very important in pools to adjust all the eyeball fittings on your return lines so that the water flow will not interfere with your pool alarm. **Point all the eyeball fittings down and your pool will still circulate properly and this will allow POOLGUARD to function properly, (See Figure 5).** Pointing the eyeball fittings down also helps prevent algae growth.

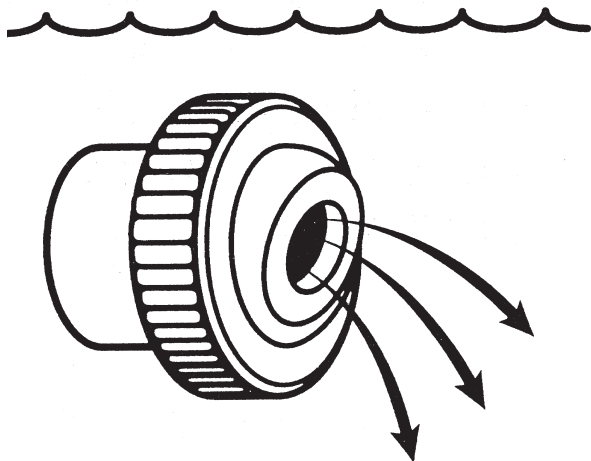

CORRECT

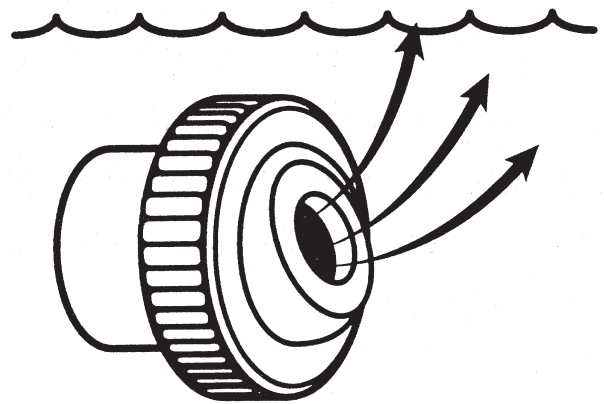

INCORRECT

FIGURE 5

POOLGUARD REMOTE RECEIVER

The POOLGUARD REMOTE RECEIVER has been integrated with the standard POOLGUARD unit to provide a wireless remote alert operating at distances of up to 200 feet. The POOLGUARD REMOTE RECEIVER sounds an alarm in the house when the POOLGUARD unit is activated at the pool. The remote system consists of the following functional elements:

- A coded pulse receiver (Remote Receiver), (See Figure 6).
- A standard wall outlet power supply, (See Figure 6).

The REMOTE RECEIVER is a compact unit powered by a **UL** and **CSA** approved AC/DC power supply. The REMOTE RECEIVER can be placed on a table or a counter top inside the house. The pulse coded radio frequency signal is transmitted from the pool unit and is received and decoded to sound the remote receiver. **The remote receiver will sound for an additional 3 seconds after the pool unit has been silenced. If the REMOTE RECEIVER beeps once approximately every 10 seconds, it is indicating that the 9v battery in the pool unit is low and needs to be replaced.** After you have purchased your POOLGUARD alarm and you wish to add another remote receiver to your alarm system you can acquire one from PBM Industries, Inc. Contact PBM by phone or mail or contact your place of purchase.

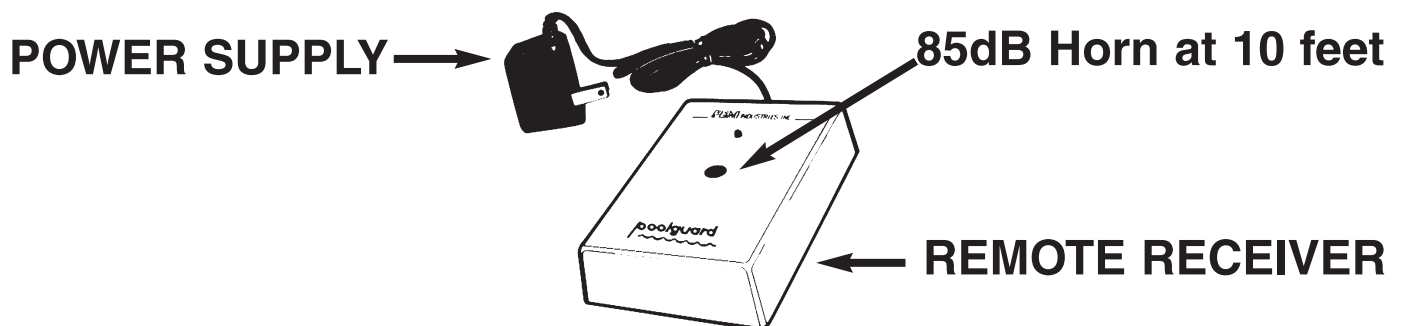

FIGURE 6

TO OPERATE YOUR REMOTE RECEIVER

Try to locate your REMOTE RECEIVER in a convenient part of your house close to the pool. Avoid steel walls or any other large metal objects or obstructions that might interfere with the signal reception. The REMOTE RECEIVER has to be placed on the same level or a level above the pool in the house (do not place receiver in an underground basement). The ideal location for your REMOTE RECEIVER would be by a window overlooking your pool. Test your REMOTE RECEIVER in different locations in your house to find the best working place for your receiver. Connect the power supply to any 120V, electrical outlet and insert the jack into the receiver. Check that indicator light is on. Your REMOTE RECEIVER unit is now ready to receive a transmission from your POOLGUARD unit. **DO NOT USE YOUR REMOTE RECEIVER OUTDOORS.**

NOTE: THE MANUFACTURER IS NOT RESPONSIBLE FOR ANY RADIO OR TV INTERFERENCE CAUSED BY UNAUTHORIZED MODIFICATIONS TO THIS EQUIPMENT. SUCH MODIFICATIONS COULD VOID THE USER'S AUTHORITY TO OPERATE THE EQUIPMENT.

SWIMMING POOL SAFETY TIPS

- **Supervise children at all times.**
- **Never permit swimming alone. Never leave a child alone, even to answer the telephone.**
- **Always remove the entire solar cover from a pool before swimming.**
- **Remember that alcohol and water safety do not mix.**
- **Have your pool area fenced and the gate locked to prevent unauthorized entry to the pool, and install a gate alarm.**
- **Lock and secure all doors in the house which permit easy access to the pool, and install a door alarm.**
- **Have a responsible adult teach swimming and water safety to your children.**
- **Maintain clean, clear water in the pool.**
- **Do not swim during electrical storms.**
- **Do not permit bottles, glass, or sharp objects to be used around the pool.**
- **Ask your pool dealer how you can improve your pool safety – they will be glad to assist you.**
- **Above all: remember that common sense, awareness, and caution will allow you to enjoy your pool.**

WARRANTY AND REPAIRS

POOLGUARD is sold with a limited warranty to cover defects in parts and workmanship for three years from date of purchase, (retain proof of purchase).

If POOLGUARD exhibits a defect, please call Customer Service at 1-800-242-7163. Unauthorized returns will not be accepted. Proper repair is only ensured when the unit is returned to the manufacturer. Visit our website at www.poolguard.com to fill out your warranty registration information. The model number and serial number are located on the pool unit.

SEND CORRESPONDENCE TO:

PBM INDUSTRIES, INC.
P.O.BOX 658, NORTH VERNON, IN 47265
1-800-242-7163

This product has been designed to aid in the detection of unwanted intrusions into unsupervised pools. POOLGUARD IS A SAFETY ALARM SYSTEM AND NOT A LIFE SAVING DEVICE. "This device is not intended to replace any other safety consideration - i.e., adult supervision, lifeguards, fences, gates, pool covers, locks, etc., and some devices may not detect gradual entry."



REV. 08/2022

HELPFUL HINTS AND TROUBLESHOOTING

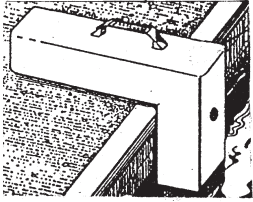

Poolside Unit

poolguard®

Power Supply



Remote Receiver

FALSE ALARMS

All pool alarms will false alarm on occasion for different reasons. False alarms can be minimized; however, it is important to remember that a false alarm is better than no alarm at all. **WEATHER & WIND**—POOLGUARD sets stationary on the deck of the pool so the wind will not effect the alarm unit itself. Wind may trigger a false alarm if it is strong enough or steady enough that it causes the water in the pool to rock or bounce up and down the pool wall. When the water in the pool moves up and down the POOLGUARD sensing throat, it may finally cause the alarm to sound. On extremely windy days when the pool water is rocking it is advised to remove the POOLGUARD from the pool. **Light wind or rain will not effect the POOLGUARD alarm.**

Another false alarm occurs when the pool owner tries to install the alarm too soon after swimming. After swimming, the water in the pool will rock or bounce up and down the pool wall for some time depending on the size of the pool and the type of swimming activity. **Before installing the alarm, after swimming, the pool must be given time to calm.** Time will vary (around 10 to 30 minutes); once the pool owner sees that the pool water is no longer rocking up and down the pool wall, it is time to install the alarm.

Certain **automatic cleaners** may set the POOLGUARD unit off in some cases. If the cleaner head hits the POOLGUARD alarm it may cause it to false alarm. Solutions to this problem are to use your cleaner at night and your alarm during the day. Another option would be to find a place around the pool where the cleaner does not interfere with the alarm. Certain **water features** such as waterfalls can cause POOLGUARD to false alarm. To avoid this problem do not install the POOLGUARD alarm too close to the water feature. If you are having a problem with any type of water feature call POOLGUARD at 1-800-242-7163.

ALARM PLACEMENT

The alarm should be on a flat, solid surface for best results. The throat of the unit is designed to work in most pools with an in-wall skimmer. The water level up on the throat is important and should be checked. The sensing throat cannot be less than 2.5 inches in the water, and not more than 5.5 inches into the water. POOLGUARD recommends that the sensing throat be approximately 4 inches in the water. POOLGUARD can be used with a solar cover; however, before removing the cover, the alarm should be taken out so it does not get pulled into the pool.

ALARM TESTING

Drop something of approximate **size, weight and volume** of the families smallest child, the farthest point away from the alarm. A four (4) gallon jug of water or 3 one (1) gallon jugs of water tied together are ideal for testing. **Remember, when testing you must wait about 15 minutes between tests for the pool to calm.**

ALARM WILL NOT SOUND

CHECK THE CONNECTION BETWEEN THE 9V BATTERY AND THE BATTERY SNAP. If you are testing and POOLGUARD does not alarm, be sure you are testing properly – putting your feet in the pool, splashing with your hands, making waves with a leaf skimmer, or dropping something into the pool that does not have the proper size, weight and volume **will not set the POOLGUARD alarm off!** Testing is very important and should be done correctly.

ALARM HANDLING

The POOLGUARD pool unit is an electronic and mechanical device made from a sturdy UV rated PVC material. Do not drop POOLGUARD; like any other appliance, it may break. The POOLGUARD pool unit is water resistant **but not waterproof** (sun and rain **will not** hurt the pool unit). Great care should be taken not to let the pool unit fall into the pool. If the pool unit does fall into the pool there are directions on page 2 in this manual on how to dry it out. **Always remember to remove the alarm before using your pool.**

REMOTE RECEIVER

When the unit at the pool alarms, the remote receiver will sound.

Maximum Range for the remote is 200 feet from the poolside unit.

Avoid placing remote in basements or close to metal walls. Be sure that the red light on the remote is on. Remember the poolside unit must be beeping (alarming) for the remote to work.

If your remote receiver is not getting a clear signal or no signal from the poolside unit, try the following: Before plugging in the power supply, be sure **to stretch out the cord**; do not leave it tied in a bow as packaged.

Your Remote Receiver is similar to a small portable radio. If your remote is not sounding when the poolside unit is sounding—move the remote to different locations and stand back for a few seconds for the remote to pick up the signal. You may only have to move your remote a little to the left or right to bring in the signal—in some cases you might have to move the remote to a different location or another room. If you cannot get a signal on your remote receiver **CALL CUSTOMER SERVICE AT 1-800-242-7163**

QUICK DO'S AND DON'TS

- Do read the manual carefully
 - Do install a 9 volt battery
 - Do untie the bow on the power supply
 - Do test the alarm properly
 - Do turn your return line eyeball fittings towards the bottom of the pool
 - Do remove alarm before swimming
 - Do store the alarm in the upright position
-

- DON'T leave alarm in pool while swimming
- DON'T drop your alarm, it may break
- DON'T let your alarm fall into the pool
- DON'T install your alarm immediately after swimming
- DON'T turn your return eyeball fittings towards the top of the pool
- DON'T use your alarm on extremely windy days



poolguard®



*The name you can trust,
since 1982.*

One source for all
your pool safety alarms,
number one in
customer service.
All products
made in the USA.



**IN GROUND
POOL ALARM**

**"SAFETY BUOY"
ABOVE GROUND
POOL ALARM**



**DOOR ALARM
SOUNDS IMMEDIATELY**



GATE ALARM



DOOR ALARM

**Poolguard's
Family of Products
Helps Protect Your Family!**

www.poolguard.com

Call Toll Free 1-800-242-7163

P.O. Box 658 • North Vernon, Indiana 47265